

diplomat[®] **SAFE**

All about Safes & Filing Cabinets



diplomat[®] **SAFE** ▲ 디프로매트 금고

Greetings from CEO

Your Satisfaction is our goal !

The managing group of Diplomat Safe Ltd extend our sincere greetings to all Diplomat Safe customers on behalf of all Diplomat Safe staffs and workers.

Since 1982, we have been engaged in shipping quality safes to global markets enjoying very high reputation. We believe that such a big success has come from all Diplomat Safe customers' interests to Diplomat safes and friendly encouragements to us.

As indicated in our company mark, we make it a rule to establish the

utmost business relationship with the customers on the basis of trust. Trust is our managing philosophy to fulfil the goal of customer satisfaction in managing the business. What we pursue is how to maximize customer satisfaction in quality, in price, in delivery and in service.

To reach these corporate goals, we keep on developing products and promoting the quality improvement on the corporate basis. Furthermore, we never stop investing to enhance the possible sources for development of new

products and quality improvements.

Promising more advanced products, faster deliveries and diversified services, we expect your everlasting supports to Diplomat Safe.

We wish all Diplomat Safe customers more prosperous and successful business and good luck.

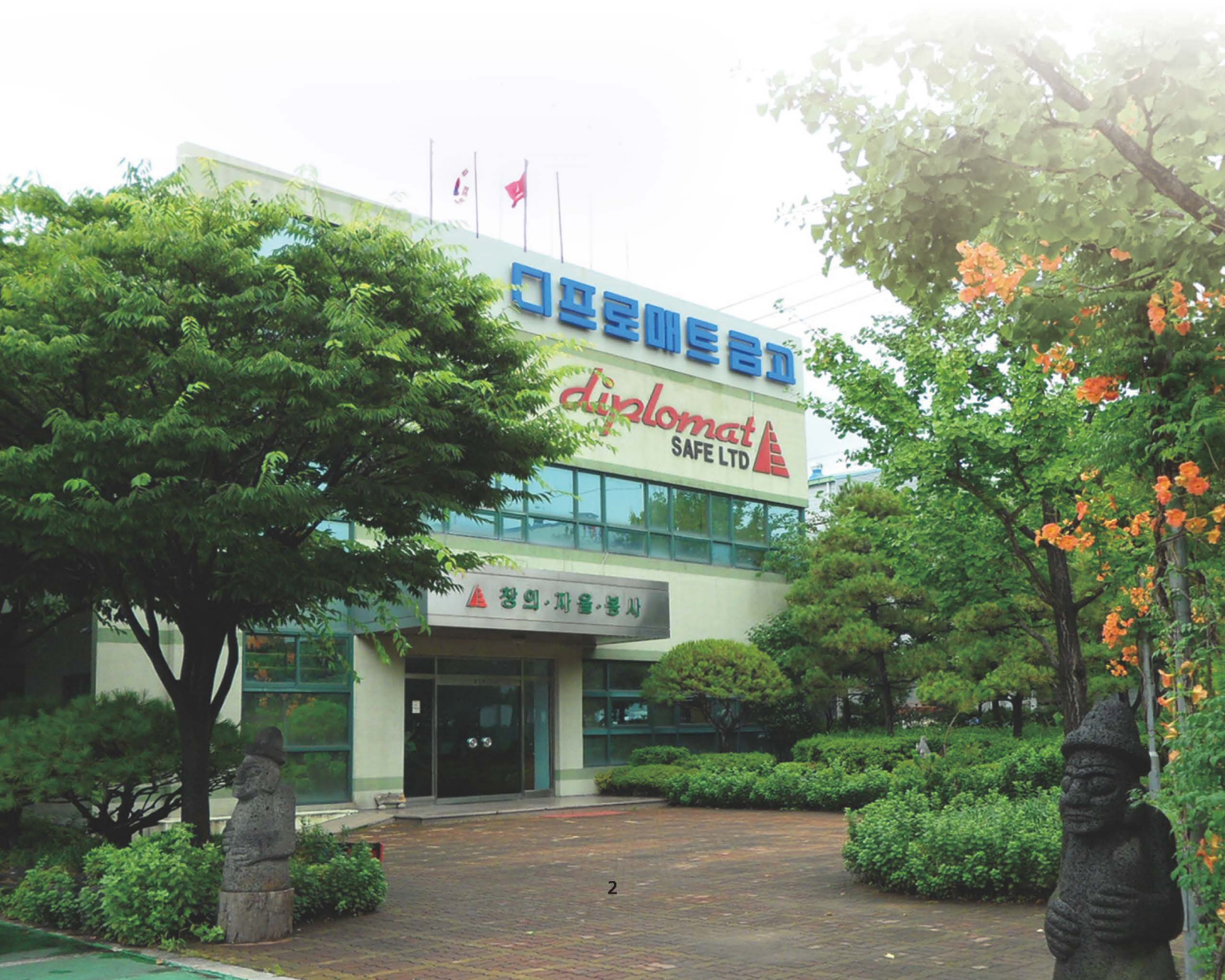



***diplomat*[®] SAFE**

www.dsafekr

About Company	2	Fire Filing Cabinets	28
- Greetings from CEO	2	- VFC, Vertical Filing Cabinet	29
- History	4	- LFC, Lateral Filing Cabinet	30
- Company Brand & Mark	5	Hotel Safes	31
- Quality Certificates & Labels	6	ROC, Reinforced Office Cabinets	32
- Fire Resistance Test	7	Security Chests & Depository Safes	34
Fire Safes	8	- Security Chest	34
- Home Safe	10	- Slot Depository Safe	34
- Home & Office Safe	11	- Depository Safe	34
- Office Safe	12	Key Cabinets	35
- DDS, Double Door Safe	13	Cash Boxes	35
- BFS, Burglary & Fire Safe	14	Deposit Boxes	36
- MFS, Multi-purpose Fire Safe	15	- FDB Series	36
Premium Fire Safes	16	- DB Series	38
- NEXT Series	16	Digital Locks	39
- DBAUM Series	18		
Fire & Security Safes	20		
- ES Series	20		
- SS Series	22		
Data Media Safes	24		
- Data Safe with Shelf only	25		
- Data Safe with Shelf and Tray	26		
- Fire Safe with Data Insert	27		

Footprints of Diplomat Safes

In 1982 a small safe company was founded in Busan, Korea, named Diplomat Safe Ltd. At the time when all the local safe manufacturers were in a deep sleep, Diplomat Safe was just born last but grew up rapidly to a top leader of fire safe manufacturing business in Korea.

Diplomat Safe Headquarters and factory are located in Noksan Industrial Complex in Busan, which is the most modern industrial park. Diplomat Safe operates its business activities worldwide and supplies all kinds of safes worldwide in a very high reputation.

Diplomat Safe never stops development of new products, improvement and innovation with new skills and techniques. In the result of everlasting and utmost customer satisfaction policy over 30 years, Diplomat Safe has finally won

the title of World Class Product Manufacturer from the Korean government in 2002. It must be an honor and pride to all Diplomat Safe customers as well as ourselves.

At present Diplomat Safe produces and handles a variety of safes such as regular Fire safes, Premium Fire safes, Data safes, Fire filing cabinets, Hotel room safes, Key cabinets, Depository safes, Deposit boxes, Electronic digital locks and Alarms. Diplomat fire safes are all certified in heat endurance test by the worldwide famous testing institutes SP, UL, GOST and KS. To keep a very high level quality and service we perform every managing process in compliance of ISO 9001 since 1996.

Diplomat safes with up-to-date electronic digital locks offer

more security and convenience, and in addition more advanced products are continuously launched in a row.

1982

1990

2000

2015



What *diplomat*[®] brand means?

In the dictionary the word 'diplomat' is defined a person who is employed to represent one country in another, such as an ambassador. We Diplomat Safe wish to make a role of ambassadors representing our country KOREA in the world with our high quality products such as various kinds of fire safes and filing cabinets.

To fulfil such a role, we must be responsible for how to make the products in higher level and how to treat our customers around the world. We remember this policy all the time and do our best to be an excellent producer of brand safes and to maximize our customers satisfaction.



Company mark means?

Our company mark  originates from a Chinese character 信, which means TRUST. The left solid triangle is from the left part (信) of the character 信, and the right one with stripes is from the right part (言) of 信.

In a word, we make it a rule to proceed all the business performances on the basis of trust. We do believe that nothing can be done without trust, especially in international business.

This mark includes two additional meanings. The left triangle represents the managing group, and the right one does workers. If either of the triangles stands alone, it looks unstable, but when both stand together, they make

another bigger stable triangle. That's the harmony we pursue.

Lastly, the right triangle with stripes gives us the importance of basics, going up step by step, finally we reach the top. That's justice in a fair business. Totally to say, it's the managing philosophy of Diplomat Safe Ltd.



Quality Certificates & Labels

Diplomat Safes passed in fire test by world class fire testing institutes.

diplomat SAFES made in the modern factory under Quality Management System ISO 9001 are assured in quality of highly reputed in the global market. They are fire resistance and stability of electronic digital lock.



ISO 9001 CERTIFIED
Quality Assurance System
ISO 9001 certified by EQA ICC

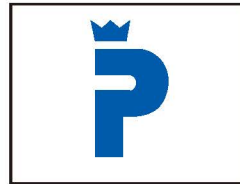

SP CERTIFIED
SP, Swedish National Testing
and Research Institute
Fire Test approved
(60P, 90P, 120P)

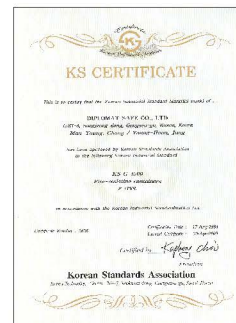

KS CERTIFIED
Fire Resistance & Impact
tested under KS G 4500
and certified P-1TKS



UL CERTIFIED
Fire Resistance tested
and certified
(UL Class 350-1 hr)



GOST CERTIFIED
Fire Resistance tested and
approved by the Russian
Committee of Certification



CE CERTIFIED
Electromagnetic safety test
CE certification for Digital
Lock and Alarm

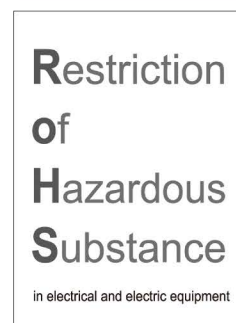

RoHS CERTIFIED
6 hazardous substances
compliance with use
restrictions in EU



ECB · S CERTIFIED
European Burglary tested
EN1143-1 Security Level Grade1
EN14450 Security Level S1

Fire Resistance Test

Safe Loaded in Furnace ①

Test specimen is loaded in the furnace. Temperatures at six(6) points inside the safe are checked by the sensors of thermocouples.

Heating Test ②③④

At the temperature of 1,010 °C the safe is heated in the airtight furnace over 60 minutes to 120 minutes. The maximum inside temperatures allowed by SP and KS are 150 °C and 177 °C respectively.

Check Result ⑤

Heating test is finished and the test safe is taken out to check if the inside paper matters are safe without burnt out. KS defines that the papers should be readable.

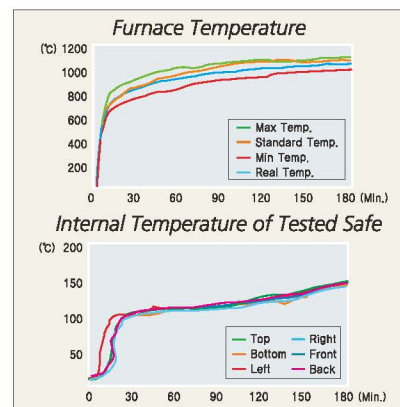
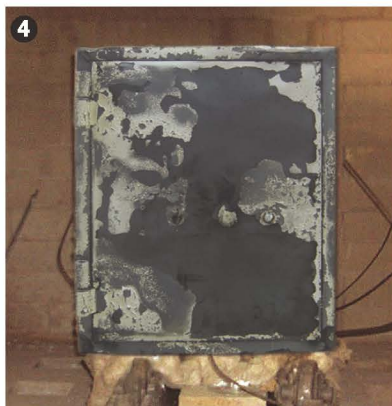
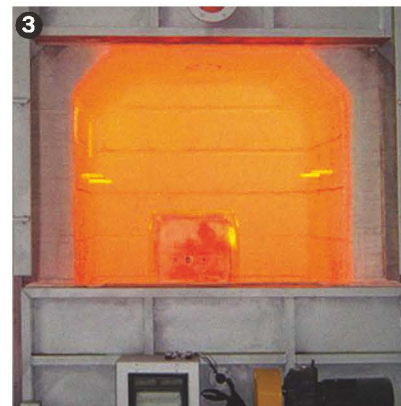
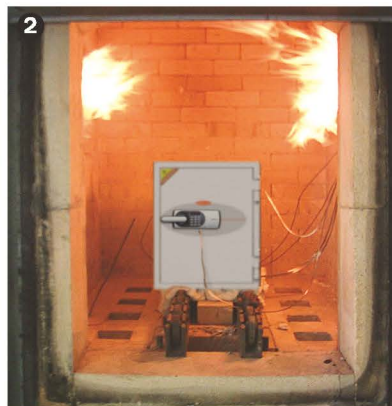

Test Result

Mark	Country	Certified Temp.	Contents
	Sweden	150°C	Paper
	Sweden	30°C / 50°C	Diskette / Data Media
	Korea	177°C	Paper
	U.S.A	177°C	Paper
	Russia	170°C	Paper

Fire Safe

Imagine what would happen if your home or business were suddenly wiped out by fire.

Insurance could replace most of your furnishings, but important documents like deeds, wills and certificates would be lost. A fire could also destroy photographs, jewelry and other irreplaceable items in a moment. There is only one effective way to protect your valuables against fires. That's to keep them in a FIRE SAFE. Most people accept that a safe is the best solution. Sizes and models are available for any purpose.

Home Safe

Home & Office Safe

Office Safe

DDS, Double Door Safe

BFS, Burglary & Fire Safe

MFS, Multi-purpose Fire Safe



Development and Innovation



Model : 130EH

-  Amazing fire resistant Insulation **STYRONITE F ①**

■ Frame ②

- Recessed double curvature frames provide virtually airtight construction preventing smoke and heat damage.

■ Accessories ③④

Model 060 and Above

- Key locking compartment drawer is provided.
- Fully adjustable shelf or shelves

Model 119 to 530

- Plastic tray
- Adjustable shelf

■ Locking Bolts ⑤⑥

Model 100 and Above

- 3 way(up and side) active bolts and recessed double curvature frames from top end to bottom end work as dead bolts.

Model 060 to 080

- 3 way(up and side) active bolts and dead bolts provide.

Model 119 to 530

- 2 way(side) active bolts and dead bolts provide.

■ Paint & Rust Free

- Top quality urethane antirust primer coated. Durable acrylic urethane leather-tone finish in smart modern colors makes the surface more smooth and bright, preventing scratches and worn-out.
- 100% top quality galvanized steel plate and antirust refined durable paint keep rust free. Every safe is cleaned to remove toxic foreign matters before painting.

■ Handle Snaps

Model 060 and Above

- Handle snaps into position automatically when door is closed.

■ Wheels ⑦

Model 060 and Above

- Wheels

Model 119 to 530

- Plastic feet

Home Safe

Keyless Electronic Digital Lock(EDL) safes offer comfort, convenience and reliability. Your memory is just a key.

 Certified by SP : 60 Paper
Certificate No. 164901



119TFL



125TSL



530EN

Drawer Safe



119EN TR5 (5 TRAYS)



Drug Safe



119EN DRUG (INNER DOOR)

■ HXWXD = HeightXWidthXDepth

	119EN	125EN	530EN
Outside (mm)	H360 X W412 X D363	H420 X W352 X D433	H522 X W404 X D440
Inside (mm)	H260 X W320 X D234	H320 X W260 X D304	H410 X W300 X D300
Weight (kg)	31	36	53
Capacity (ℓ)	19	25	36
Tray (pc)	1	1	1
Shelf (pc)	-	1	1
Fire Class	60 Paper	60 Paper	60 Paper

■ Height includes Plastic feet of 8mm. ■ Color :  Ivory (RAL9002) /  Black(RAL7021) /  GNC(Green Combi)

Available Locking System

• Digital Lock

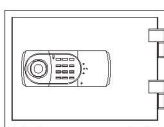

EN
(EDL77 or EDL88 + Knob)

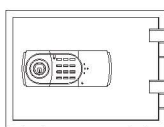

EK
(EDL77 or EDL88 + Keylock)

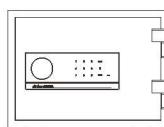

TSL
(Touch Screen Lock)

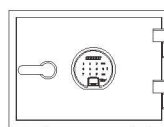

TFL
(Touch Screen & Finger Print Lock + Handle)

• Mechanical Lock

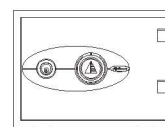

KC
(Keylock + Combination Lock)

Home & Office Safe

We recommend technically advanced Electronic Digital Locks(EDL) for better security and more convenience.

 Certified by SP : 90 Paper
Certificate No. 164902



O60TFL



O70TSL-K



O80EH

■ HXWXD = HeightXWidthXDepth

	O60EH	O70EH	O80EH
Outside (mm)	H660 X W470 X D470	H695 X W500 X D500	H876 X W520 X D520
Inside (mm)	H480 X W350 X D300	H515 X W380 X D330	H676 X W380 X D330
Weight (kg)	80	90	122
Capacity (ℓ)	50	64	84
Tray (pc)	1	1	1
Shelf (pc)	1	1	1
Fire Class	90 Paper	90 Paper	90 Paper

■ Height includes Wheels of 60mm. ■ Color :  Ivory (RAL9002) /  Black(RAL7021) /  GNC(Green Combi)

Available Locking System

• Digital Lock

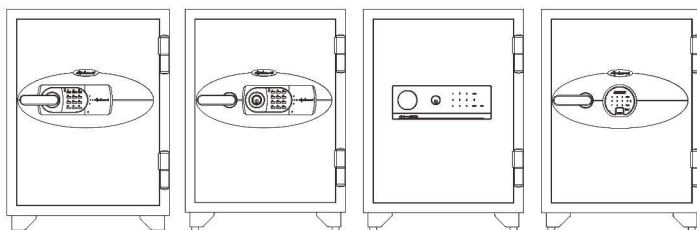

EH
(EDL77or EDL88 + Handle)

EHK
(EDL77or EDL88 + Keylock + Handle)

TSL-K
(Touch Screen Lock + Keylock)

TFL
(Touch Screen + Finger Print Lock + Handle)

• Mechanical Lock

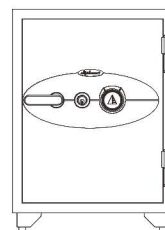

KC
(Keylock + Combination Lock+ Handle)

Office Safe

If you are requested to open your safe more than three times a day, we recommend Electronic Digital Lock(EDL) safe wherever it is used at home or in the office.

 Certified by SP 120 Paper
Certificate No. 164903

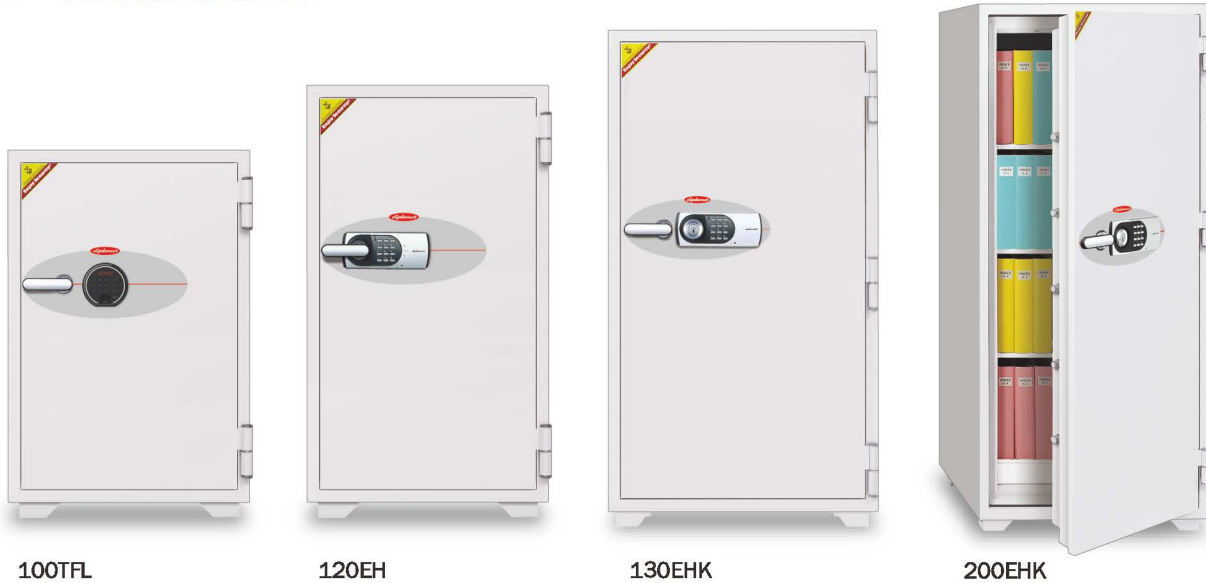

■ H X W X D = Height X Width X Depth

	100EH	120EH	130EH	200EH
Outside (mm)	H1020 X W655 X D560	H1220 X W655 X D560	H1445 X W775 X D650	H1690 X W775 X D650
Inside (mm)	H780 X W475 X D350	H980 X W475 X D350	H1205 X W595 X D440	H1450 X W595 X D440
Weight (kg)	201	228	348	388
Capacity (ℓ)	129	162	315	379
Tray (pc)	1	1	1	1
Shelf (pc)	2	2	3	3
Fire Class	120 Paper	120 Paper	120 Paper	120 Paper

■ Height includes Wheels of 60mm. ■ Color :  Ivory (RAL9002) /  Black(RAL7021) /  GNC(Green Combi)

Available Locking System

• Digital Lock

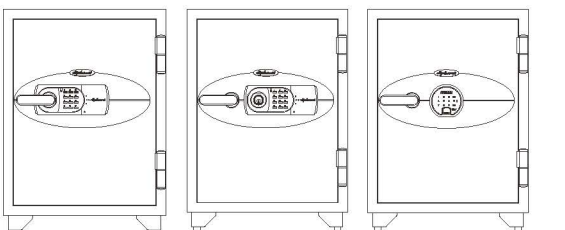

EH
(EDL.77 or EDL.88 + Handle)

EHK
(EDL.77 or EDL.88 + Keylock + Handle)

TFL
(Touch Screen & Finger Print Lock + Handle)

• Mechanical Lock

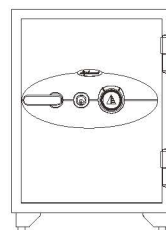

KC
(Keylock + Combination Lock + Handle)

DDS Double Door Safe

Some businesses often require very special size safes in dimensions for some irregular binders, drawings or office equipments.

 Certified by SP 120 Paper
Certificate No. 164906

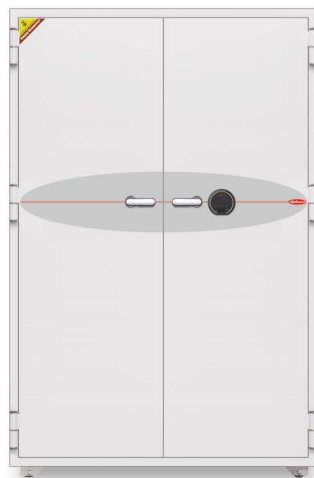

L300TFL

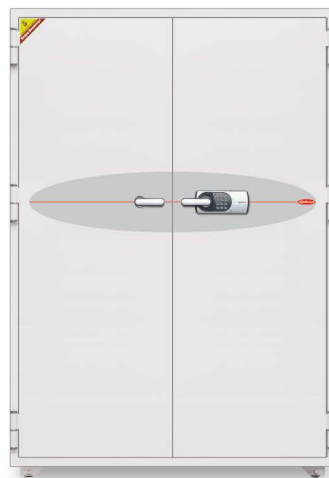

W300EH



C300EHK

■ H X W X D = Height X Width X Depth

	L300EH	W300EH	C300EH
Outside (mm)	H1745 X W1126 X D700	H1745 X W1200 X D720	H1925 X W950 X D560
Inside (mm)	H1505 X W946 X D490	H1505 X W1020 X D510	H1685 X W770 X D350
Weight (kg)	540	560	470
Capacity (ℓ)	698	783	454
Tray (pc)	2	2	-
Shelf (pc)	3	3	4
Fire Class	120 Paper	120 Paper	120 Paper

■ Height includes Wheels of 60mm. ■ Color :  Ivory (RAL9002) /  Black(RAL7021) /  GNC(Green Combi)

Available Locking System

• Digital Lock

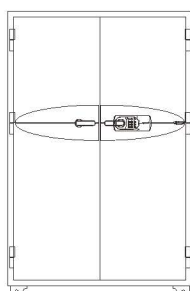

EH
(EDL77 or EDL88 + Handle)

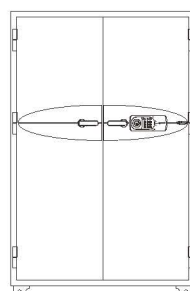

EHK
(EDL77 or EDL88 + Keylock + Handle)

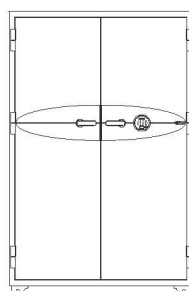

TFL
(Touch Screen & Finger Print Lock + Handle)

• Mechanical Lock

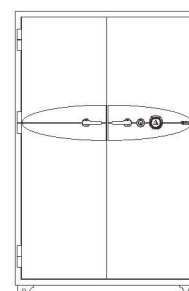

KC
(Keylock + Combination Lock + Handle)

BFS Burglary Fire Safe

In addition, 6 different size models are provided for easy selection for home, office or commercial use.

 Certified by SP 90/120 Paper
Certificate No. 164902, 164903



BF070EH



BF080EH



BF100EH / BF120EH



BF130EH / BF200EH

■ H X W X D = Height X Width X Depth

	BF070EH	BF080EH	BF100EH
Outside (mm)	H695 X W500 X D500	H876 X W520 X D520	H1020 X W655 X D560
Inside (mm)	H515 X W380 X D330	H676 X W380 X D330	H780 X W475 X D350
Weight (kg)	111	143	232
Capacity (ℓ)	64	84	129
Tray/Shelf (pc)	1 / -	1 / 1	1 / 1
Fire Class	90 Paper	90 Paper	120 Paper

	BF120EH	BF130EH	BF200EH
Outside (mm)	H1220 X W655 X D560	H1445 X W775 X D650	H1690 X W775 X D650
Inside (mm)	H980 X W475 X D350	H1205 X W595 X D440	H1450 X W595 X D440
Weight (kg)	259	379	419
Capacity (ℓ)	162	315	379
Tray/Shelf (pc)	1 / 1	1 / 2	1 / 2
Fire Class	120 Paper	120 Paper	120 Paper

- Height includes Wheels of 60mm.
- Color :  Ivory (RAL9002) /  Black(RAL7021) /  GNC(Green Combi)
- Inner steel box inside : BF070EH, BF080EH : H214 X W372 X D226 mm / BF100EH, BF120EH : H294 X W467 X D246 mm / BF130EH, BF200EH : H344 X W587 X D336 mm

Available Locking System

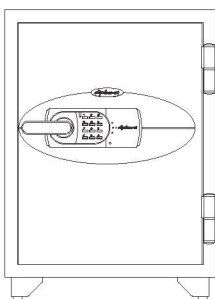

EH
(EDL77or EDL88 + Handle)

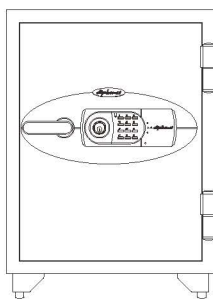

EHK
(EDL77or EDL88 + Keylock + Handle)

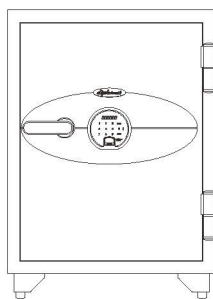

TFL
(Touch Screen & Finger Print Lock + Handle)

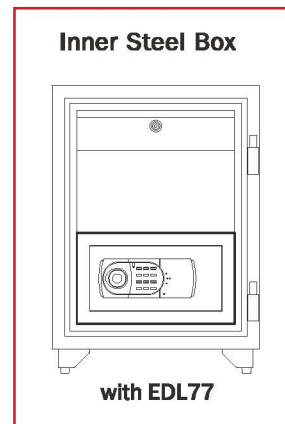

MFS Multipurpose Fire Safe

Optional Fittings : Pull-out Shelf, Pull-out Drawer, Pull-out Hanger, Data Insert

Certified by SP 120 Paper
Certificate No. 164903, 164906

■ Drawing of virtual combination

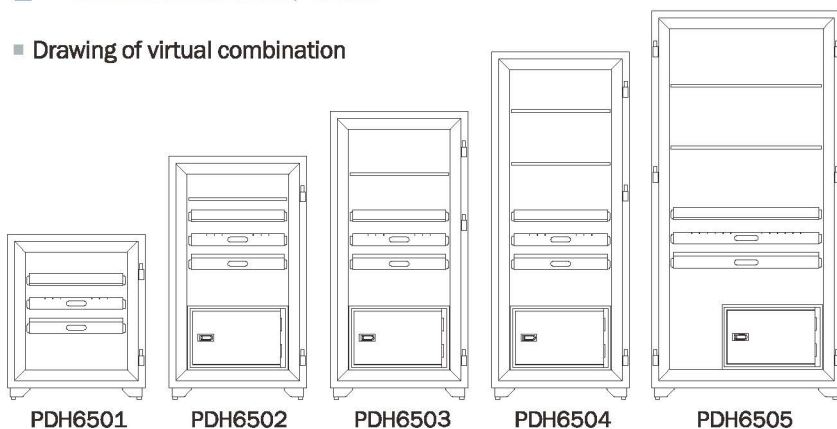





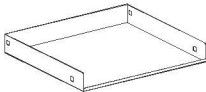
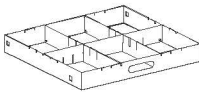
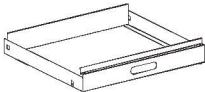
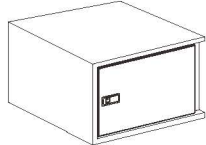

■ H X W X D = Height X Width X Depth

	PDH6501	PDH6502	PDH6503	PDH6504	PDH6505
Outside (mm)	H830 X W690 X D650	H1220 X W690 X D650	H1445 X W690 X D650	H1745 X W690 X D650	H1925 X W950 X D650
Inside (mm)	H590 X W510 X D440	H980 X W510 X D440	H1205 X W510 X D440	H1505 X W510 X D440	H1685 X W770 X D440
Weight (kg)	199	260	378	430	485
Capacity (ℓ)	132	220	270	338	571
Fire Class	120 Paper	120 Paper	120 Paper	120 Paper	120 Paper
Fixed Shelf	option	option	option	option	option
Pull-out Shelf	"	"	"	"	"
Pull-out Drawer	"	"	"	"	"
Pull-out File Hanger	"	"	"	"	"
Data Insert	"	"	"	"	"

■ Above weight doesn't include interior. ■ Height includes Wheels of 60mm. ■ Color : Ivory (RAL9002)

Interior

Fixed Shelf	Pull-out Shelf	Pull-out Drawer	Pull-out File Hanger	Data Insert
				
PDH 6501 ~ PDH6504 H23 X W490 X D430 / 2kg	PDH 6501 ~ PDH6504 H60 X W490 X D430 / 5kg	PDH 6501 ~ PDH6504 H60 X W468 X D430 / 6kg	PDH 6501 ~ PDH6504 H77 X W451 X D430 / 3kg	PDH 6501 ~ PDH6505 Outside : H320 X W490 X D430 Inside : H221 X W391 X D339
PDH 6505 H23 X W752 X D430 / 3.9kg	PDH 6505 H60 X W728 X D430 / 6.8kg	PDH 6505 H60 X W728 X D430 / 9kg	PDH 6505 H77 X W728 X D430 / 4.5kg	21kg
				

NEXT deserves to be a masterpiece in design, security and convenience.



Height adjustable shelf



Wooden Slide Drawer

■ **Modern refined design**

- Special door panels
- Slide Cover for Lock hide
- Well finished smart plinth

■ **Spacious Interior**

- More useful inside space
- Adjustable Shelf
- Wooden drawers

■ **Fire & Burglary protection**

- 1 hour fire resistance
- MTC D120616
 - 60Min under NT FIRE017
 - RSC in Security by UL1037



Reinforced Locking Bolts (\varnothing 32)



Smoke and Heat blocking frames



Implantable Hinge



Anti-drill steel plate on major points



Relocking Device

NEXT has four models in size and color.



DPS5500 (Black)



DPS6500 (Wood)



DPS7500 (Cherry)



DPS8500 (White)

■ H X W X D = Height X Width X Depth

	DPS 5500	DPS 6500	DPS 7500	DPS 8500
Outside (mm)	H600 X W500 X D541	H700 X W500 X D541	H800 X W500 X D541	H900 X W500 X D541
Inside (mm)	H430 X W380 X D320	H530 X W380 X D320	H630 X W380 X D320	H730 X W380 X D320
Weight (kg)	115	130	145	160
Capacity (ℓ)	52	64	76	88
Shelf (pc)	1	1	2	2
Drawer (pc)	1	1	2	2
Fire Class	60 Paper	60 Paper	60 Paper	60 Paper

■ Height includes Plinth of 50mm. ■ Drawer Inside - DPS5500/DPS6500 : H72 x W285 x D265 mm
 - DPS7500/DPS8500 : Upper H82 x W285 x D265 mm, Lower H72 x W285 x D265 mm

Available Color



Available Locking System

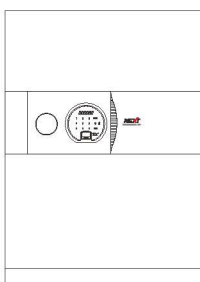

TFL
(Touch Screen & Finger Print Lock + Knob)

TFL, Touch Screen & Finger Print Lock

- ① FND Display of user code
- ② User Code : 4 to 16 digits
- ③ 128 finger prints are acceptable
- ④ Scramble numbers
- ⑤ Paralysis function
- ⑥ Dual Control function
- ⑦ Built-in Alarm
- ⑧ Low battery indication

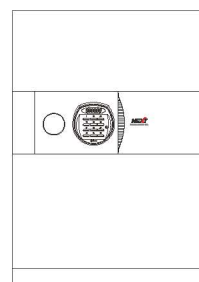

R3
(R3 + Knob)

Button Digital Lock R3

- ① FND Display of user code
- ② User Code : 4 to 16 digits
- ③ Code & Sound hide function
- ④ Scramble numbers
- ⑤ Paralysis function
- ⑥ Dual Control function
- ⑦ Built-in Alarm
- ⑧ Low battery indication

DBAUM is decorated with genuine walnut panel on the door.

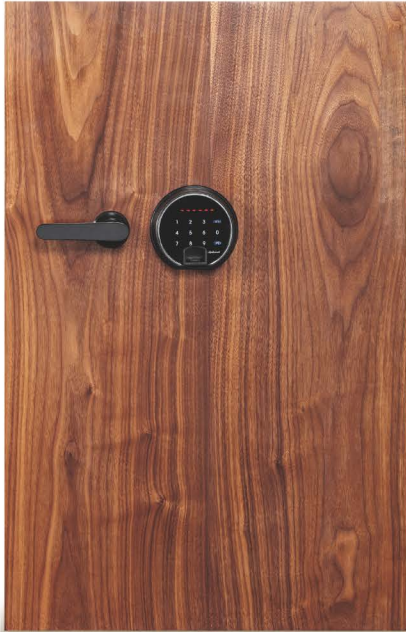

DBAUM 800



DBAUM 800
Option (Drawer 7pcs)



Slide Drawer with walnut head



Height adjustable shelf



Key hangers on door back

■ **Genuine Wooden Door Panel**

- Walnut Door Panel
- Neat Bottom without wheels

■ **Productive Interior**

- Walnut Drawer Head
- Adjustable Shelf
- Optional Drawers, Shelves

■ **Fire Resistance Certified**

- 60P, 90P by SP, Sweden
- Smoke & Heat block frame structure
- Each drawer insulated independently (DBAUM S200)



DBAUM S200

Grooved Knob



Hidden Drawer in Upper Drawer



Smooth Slide Rail



Divider in Lower Drawer



Open & Close Hook in Lower Drawer

DBAUM has four models in size.

Basic



DBAUM 500
Drawer 1 / Shelf 1

DBAUM 700
Drawer 1 / Shelf 1

DBAUM 800
Drawer 1 / Shelf 2

DBAUM S200

Option



DBAUM 500
Drawer 4

DBAUM 700
Drawer 5

DBAUM 800
Drawer 7

■ H X W X D = Height X Width X Depth

	DBAUM 500	DBAUM 700	DBAUM 800	DBAUM S200
Outside (mm)	H522 x W404 x D468	H643 x W500 x D528	H824 x W520 x D548	H734 x W522 x D521
Inside (mm)	H410 x W300 x D300	H515 x W380 x D330	H676 x W380 x D330	H276 x W400 x D342
Weight (kg)	58	100	135	105
Capacity (ℓ)	36	64	84	76
Fire Class	60 Paper	90 Paper	90 Paper	60 Paper

- Height includes Plastic feet of 8mm. ■ Drawer Inside : DBAUM500 : Small H70 x W265 x D255 mm / Large H150 x W265 x D255 mm
DBAUM700/800 : Small H70 x W345 x D290 mm / Large H150 x W345 x D290 mm
- Customized interior options with additional drawers. ■ NOTE : Because of using genuine wood, the pattern of every panel can't be same.

Available Locking System



TFL

TFL, Touch Screen & Finger Print Lock

- ① FND Display of user code
- ② User Code : 4 to 16 digits
- ③ 128 finger prints are acceptable
- ④ Scramble numbers
- ⑤ Paralysis function
- ⑥ Dual Control function
- ⑦ Built-in Alarm
- ⑧ Low battery indication



NABI

Button Digital Lock NABI

- ① Stylish Butterfly Shape Keypad
- ② 6 digit user code
- ③ Easy and simple to enter user code
- ④ LED display for codes and signs
- ⑤ Motorized bolt-work locking system

ES Series

Certified ECB·S EN1143-1 Security Level Grade1



■  Specially reinforced with **Steel Bar Mesh** in Hard Concrete ①

■  Fire Protection for 60min according to NT FIRE 017 60 Paper

■ **Frame ②**

- Recessed double curvature frames provide virtually airtight construction preventing smoke and heat damage.

■ **Accessories ③ ④**

- Key locking compartment drawer is provided. (Except ES600)
- Fully adjustable shelf or shelves
- Spacious interior dimensions allow for more efficient and larger storage area.

■ **Locking Bolts ⑤ ⑥**

- Durable boltwork (sides/up/down, $\varnothing 32$)
- Recessed double curvature frames from top end to bottom end work as dead bolts.

■ **Re-locker(s) provides more security.**

■ **Paint & Rust Free**

- Top quality urethane antirust primer coated. Durable acrylic urethane leather-tone finish in smart modern colors makes the surface more smooth and bright, preventing scratches and worn-out.
- 100% top quality galvanized steel plate and antirust refined durable paint keep rust free. Every safe is cleaned to remove toxic foreign matters before painting.

■ **Projection**

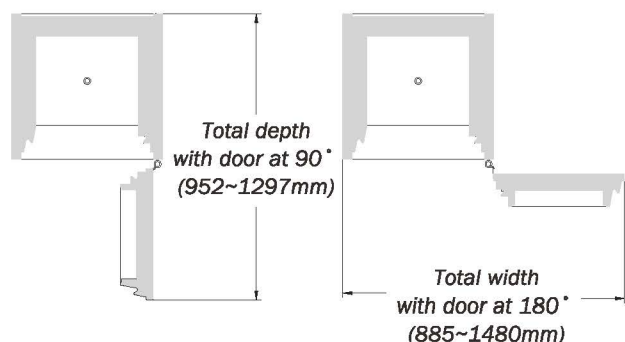

 **ECB·S Burglary tested**
European Certification Board·Security System
EN1143-1 Security Level Grade1



ES Series

How to protect Documents, Valuables and Cash Notes or Coins more Safely?
ES Series Security Safe offers a right solution.

 Certified by SP 60 Paper
Certificate No. SC0503-12



ES600
with Mauer Key Lock



ES700
with LaGard Electronic Lock



ES1000 / ES1200
with Mauer Key Lock



ES1400
with LaGard Electronic Lock

■ H X W X D = Height X Width X Depth

	ES600	ES700	ES1000	ES1200	ES1400
Outside (mm)	H590 X W480 X D510	H695 X W560 X D540	H960 X W655 X D560	H1160 X W655 X D560	H1385 X W655 X D560
Inside (mm)	H410 X W300 X D300	H515 X W380 X D330	H780 X W475 X D350	H980 X W475 X D350	H1205 X W475 X D350
Weight (kg)	245	330	500	590	680
Capacity (ℓ)	36	64	129	162	200
Tray (pc)	1	1	1	1	1
Shelf (pc)	1	1	2	2	3
Fire Class	60 Paper	60 Paper	60 Paper	60 Paper	60 Paper

■ Color :  Ivory (RAL9002)

Available Locking System

EN1300 Class A (ECB · S) Vds Class 1

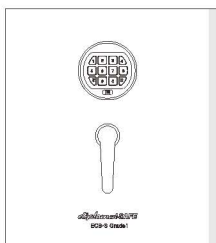

Electronic Lock
(LaGard 4200)

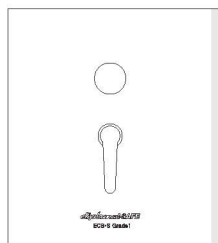

Key Lock
(Mauer 71111)

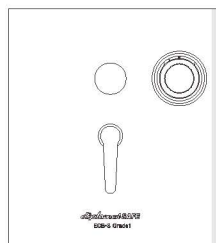

Key Lock + Combination Lock
(Mauer 71111 + LaGard 1777)

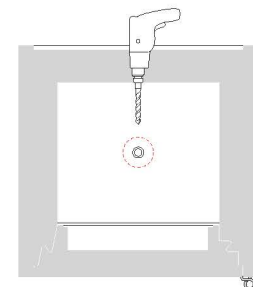

**1 Anchoring Bolt
on Bottom**



SS Series

Certified ECB · S EN14450 Security Level S1



-  Amazing fire resistant Insulation **STYRONITE F ①**
-  Fire Protection for 60min according to NT FIRE 017 60 Paper
- **Frame ②**
 - Recessed double curvature frames provide virtually airtight construction preventing smoke and heat damage.
- **Accessories ③④**
 - Key locking compartment drawer is provided.
 - Fully adjustable shelf or shelves
 - Spacious interior dimensions allow for more efficient and larger storage area.
 - Sophisticated Die-casting Handle
- **Locking Bolts ⑤⑥**
 - Durable boltwork (sides/up/down, $\varnothing 22$)
 - Recessed double curvature frames from top end to bottom end work as dead bolts.
- **Re-locker(s) provides more security.**
- **Paint & Rust Free**
 - Top quality urethane antirust primer coated. Durable acrylic urethane leather-tone finish in smart modern colors makes the surface more smooth and bright, preventing scratches and worn-out.
 - 100% top quality galvanized steel plate and antirust refined durable paint keep rust free. Every safe is cleaned to remove toxic foreign matters before painting.

 **ECB · S Burglary tested**
European Certification Board · Security System
EN14450 Security Level S1

CERTIFICATE



The European Certification Board (ECB) certifies
Diplomat Safe Ltd.
18834 Friedrichsberg, Germany, as a member of
the right to carry the ECB-S certification mark for
the safe with laboratory of fire and burglar test according to EN 15040:2007 and EN 15040:2012 (category 3, 1-11)
Diplomat Safe Ltd. (ECB-S) member since 2014. (EN 15040:2007 and EN 15040:2012)

Certificate number
110555021041
This certificate will expire on
9 July 2018

17 January 2018
Diplomat Safe Ltd.
Diplomat Safe Ltd.
Diplomat Safe Ltd.

ECB · S

Recommended Insurance amounts in the private sector in Germany : € 5,000.00

■ **Projection**

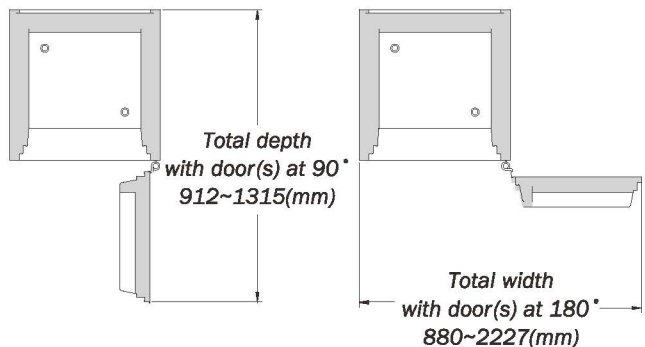

SS Series

How to protect Documents, Valuables and Cash? SS Series offer right answer.

 Certified by SP 90/120 Paper
Certificate No. 164903, 164906



SS060/SS070/SS080
with Mauer Key Lock



SS100/SS120
with LaGard Digital Lock



SS130 / SS200
with Mauer Key Lock



SSL300
with LaGard Digital Lock

■ H X W X D = Height X Width X Depth

	SS060	SS070	SS080	SS100
Outside (mm)	H600 X W470 X D470	H635 X W500 X D500	H816 X W520 X D520	H960 X W655 X D560
Inside (mm)	H480 X W350 X D300	H515 X W380 X D330	H676 X W380 X D330	H780 X W475 X D350
Weight (kg)	80	90	122	201
Capacity (ℓ)	50	64	84	129
Tray (pc)	1	1	1	1
Shelf (pc)	1	1	1	2
Fire Class	90 Paper	90 Paper	90 Paper	120 Paper

	SS120	SS130	SS200	SSL300
Outside (mm)	H1160 X W655 X D560	H1385 X W775 X D650	H1630 X W775 X D650	H1685 X W1126 X D700
Inside (mm)	H980 X W475 X D350	H1205 X W595 X D440	H1450 X 595 X D440	H1505 X W946 X D490
Weight (kg)	228	348	388	540
Capacity (ℓ)	162	315	379	698
Tray (pc)	1	1	1	-
Shelf (pc)	2	3	3	3
Fire Class	120 Paper	120 Paper	120 Paper	120 Paper

■ Color :  Ivory (RAL9002)

Available Locking System

EN1300 Class A (ECB · S) Vds Class 1

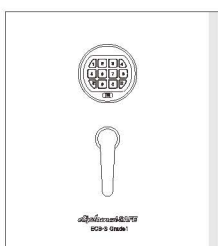

Electronic Lock
(LaGard 4200)

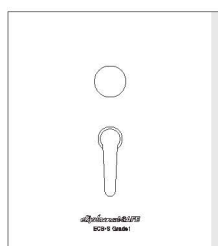

Key Lock
(Mauer 71111)

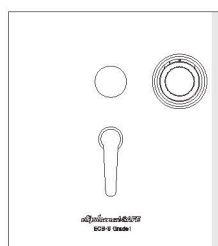

Key Lock + Combination Lock
(Mauer 71111 + LaGard 1777)

**2 Anchoring Bolt
on Bottom**

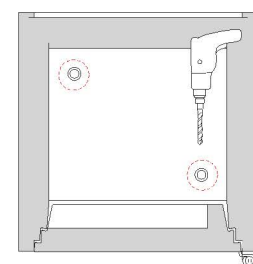

Data Media Safes

How safely your computer media are protected against fire?



Computer media such as diskettes and floppy discs may be easily damaged in a low level of heat (above 50 °C) or humidity (above 85%). For example, even a cup of boiling coffee can destroy your data materials seriously.

The lost data by heat or humidity can't be recovered in a short time because most of them are the piled business records related with the customers for a long period. It is reported that many of the businesses affected by fire suffer from the damages and are declined in the end. This could happen to you at home or in the office.

But, you can be free from such worries with **Diplomat Data Safe**. **Diplomat Data Safe** certified by SP (Swedish National Testing & Research institute) will protect your business records from fire, humidity and unauthorized access. **Diplomat Data Safe** is constructed with a regular fire safe and a multilayer anti-thermo insert to block heat, smoke and humidity.

Interior heat endurance test by SP

Diplomat Data Safe is fire-tested and approved by SP (Swedish National Fire Testing & Research Institute).

The heat endurance of the insert has been checked with six thermal couples at six different points (25mm apart from the surface of two sides, door, back, top and bottom), and each thermal couple should indicate less than 50 °C for certification. All Diplomat inserts passed 120 minutes at the temperatures of 40 °C to 45 °C.

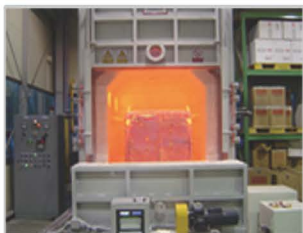

Fire test



Insert Heat test



Safely protected data materials

Data Safe with Shelf only



Certified by SP 60 Data 60 Diskette / 90 Data 90 Diskette
Certificate No. 164907



Shelf



DS1125EN / DS1530EN



DS1060EH



DS1070EH

■ H X W X D = Height X Width X Depth

	DS1125EN	DS1530EN	DS1060EH	DS1070EH
Outside (mm)	H420 X W352 X D433	H 522 X W404 X D440	H660 X W470 X D470	H695 X W500 X D500
Inside (mm)	H224 X W157 X D206	H314 X W197 X D201	H384 X W247 X D201	H419 X W277 X D231
Weight (kg)	43	65	99	117
Shelf (pc)	1	1	2	2
Fire Class	60 Data, 60 Diskette	60 Data, 60 Diskette	90 Data, 90 Diskette	90 Data, 90 Diskette

- Height includes Plastic feet of 8mm(DS1125,DS1530) or Wheels of 60mm(DS1060, DS1070).
- Data : Grade for the media to be stored at less than 50 °C in fire. (Available Media - 3.5", CD)
Diskette : Grade for the media to be stored at less than 30 °C in fire. (Available Media - 3.5", CD, 4mm DAT, 8mm AIT, DLT, LT, 3590 Cartridge)
- Color : Ivory (RAL9002)

Model	Fire Class	Media Quantity (pcs)						
		4mm Dat	8mm / AIT	CD	DLT	LTO / Ultrium (HP)	LTO / Ultrium (Without case)	3590 Cartridge (Without case)
DS1125EN	60Data, 60Diskette	74	33	30	16	-	22	12
DS1530EN	60Data, 60Diskette	150	54	53	20	-	36	22
DS1060EH	90Data, 90Diskette	236	103	87	44	-	63	45
DS1070EH	90Data, 90Diskette	312	168	111	62	-	96	64

Data Safe with Shelf and Tray

P Certified by SP 120 Data 120 Diskette
Certificate No. 164907



Shelf H15 X W393 X D395 mm Tray H58 X W368 X D397 mm



■ H X W X D = Height X Width X Depth

	DT2825EH	DT2120EH	DT2130EH	DT2200EH	DT2300EH
Outside (mm)	H830 X W690 X D720	H1220 X W690 X D720	H1445 X W690 X D720	H1745 X W690 X D720	H1745 X W1200 X D720
Inside (mm)	H489 X W402 X D406	H879 X W402 X D406	H1104 X W402 X D406	H1404 X W402 X D406	(H1404 X W402 X D406) X 2
Weight (kg)	254	337	469	541	765
Shelf (pc)	1 / 2	1 / 4	1 / 5	2 / 5	4 / 10
Fire Class	120 Data, 120 Diskette	120 Data, 120 Diskette	120 Data, 120 Diskette	120 Data, 120 Diskette	120 Data, 120 Diskette

- Height includes Wheels of 60mm.
- Data : Grade for the media to be stored at less than 50 °C in fire. (Available Media - 3.5", CD)
Diskette : Grade for the media to be stored at less than 30 °C in fire. (Available Media - 3.5", CD, 4mm DAT, 8mm AIT, DLT, LT, 3590 Cartridge)
- Color : Ivory (RAL9002)

Model	Fire Class	Media Quantity (pcs)						
		4mm Dat	8mm / AIT	CD	DLT	LTO / Ultrium (HP)	LTO / Ultrium (Without case)	3590 Cartridge (Without case)
DT2825EH	120Data, 120Diskette	580	285	282	126	132	171	144
DT2120EH	120Data, 120Diskette	1276	627	564	294	308	399	288
DT2130EH	120Data, 120Diskette	1508	741	752	378	396	513	384
DT2200EH	120Data, 120Diskette	1972	969	940	462	484	627	480
DT2300EH	120Data, 120Diskette	3944	1938	1880	924	968	1254	960

Fire Safe with Data Insert

P Certified by SP 90 Data 90 Diskette / 120 Data 120 Diskette
Certificate No. 164907



Insert (DIS 0708)
without Shelf



Insert (DIS 1120)
with 2 Shelves



DC3070EH



DC3080EH



DC3100EH



DC3120EH

■ H X W X D = Height X Width X Depth

	DC3070EH	DC3080EH	DC3100EH	DC3120EH	
Outside (mm)	H695 X W500 X D500	H876 X W520 X D520	H1020 X W655 X D560	H1220 X W655 X D560	
Paper Section	Inside (mm)	H305 X W380 X D330	H466 X W380 X D330	H335 X W475 X D350	
	Shelf / Tray (pc)	1 / 1	1 / 1	1 / 1	
	Fire Class	90 Paper	90 Paper	120 Paper	120 Paper
Data Section	Inside (mm)	H104 X W275 X D231	H104 X W275 X D231	H339 X W372 X D251	
	Shelf (pc)	-	-	2	2
	Fire Class	90 Data, 90 Diskette	90 Data, 90 Diskette	120 Data, 90 Diskette	120 Data, 90 Diskette
Weight (kg)	100	132	223	250	

- Height includes Wheels of 60mm.
- Data : Grade for the media to be stored at less than 50°C in fire. (Available Media - 3.5", CD)
Diskette : Grade for the media to be stored at less than 30°C in fire. (Available Media - 3.5", CD, 4mm DAT, 8mm AIT, DLT, LT, 3590 Cartridge)
- Color : Ivory (RAL9002)

Model	Fire Class	Media Quantity (pcs)							
		4mm Dat	8mm / AIT	CD	DLT	LTO / Ultrium (HP)	LTO / Ultrium (Without case)	3590 Cartridge (Without case)	
DIS0708	DC3070EH	90Data, 90Diskette	64	34	20	12	-	24	8
	DC3080EH	90Data, 90Diskette	64	34	20	12	-	24	8
DIS1120	DC3100EH	120Data, 90Diskette	396	186	108	72	-	111	74
	DC3120EH	120Data, 90Diskette	396	186	108	72	-	111	74

Fire Filing Cabinets

A smart and sound Diplomat Fire Filing Cabinet gives convenience and security at home or in the office.



VFC,
Vertical Fire Filing Cabinet

LFC,
Lateral Fire Filing Cabinet

- Insulation is Diplomat's own amazing fire resistant STYRONITE F.
- Simply designed rimmed knob and card holder looks smart
- The frame of drawer fits the body without play.
- Heavy duty suspension slide rails make the drawer move back and forth smooth and endure the weight up to 50kg(VFC) / 45kg(LFC).
- Each drawer is isolated from the others in fire.
- Tight construction of body and drawer prevents from smoke and heat.

Fire Tested and Certified



- ▶ Diplomat Fire Resistant Filing Cabinets have been fire tested and approved in compliance with NT FIRE 017
- ▶ Fire Class : 60 Paper



1 Before heating



2 Heating



3 After heating



4 Interior of tested drawer

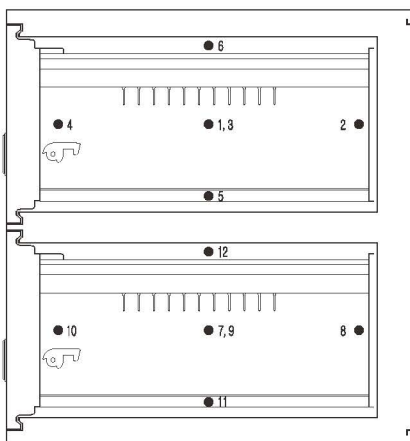

● Location of Thermocouples

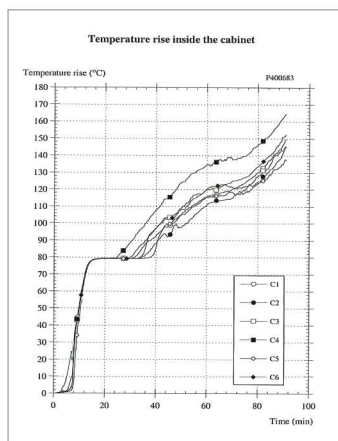

● Heat Graph (C1-6)

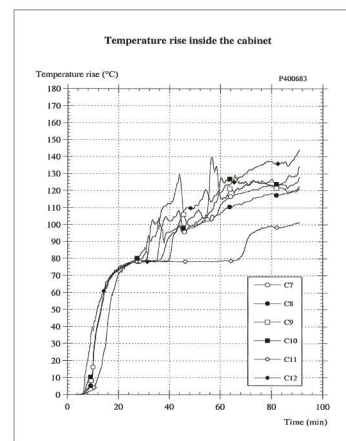

● Heat Graph (C7-12)

VFC Vertical Filing Cabinet

P Certified by SP 60 Paper
Certificate No. 164905



DFC 2000K
with Keylock



DFC 3000KC
with Key Lock &
Changeable Combination Lock



DFC 4000E
with Digital Lock R2

■ H X W X D = Height X Width X Depth

	DFC2000	DFC3000	DFC4000
Outside (mm)	H782 X W528 X D675	H1124 X W528 X D675	H1466 X W528 X D675
Weight (kg)	145	206	266
Fire Class	60 Paper	60 Paper	60 Paper

■ Height includes Wheels of 60mm . ■ Drawer Inside : H254xW384xD505mm (49ℓ) ■ Color : Ivory (RAL9002)

Available Locking System

• Digital Lock



Digital Lock (R2 or R3)



Touch & Finger-print Lock

• Mechanical Lock



Plunger Lock



Key Lock



Key Lock & Changeable
Combination Lock

Drawer

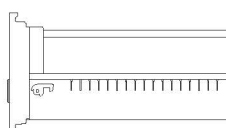

Inside : H254 X W384 X D505 mm
Capacity : 49ℓ

LFC Lateral Filing Cabinet

P Certified by SP 60 Paper
Certificate No. SC1334-13



LFC2-31K
with Keylock



LFC3-38KC
with Key Lock &
Changeable Combination Lock



LFC4-44E
with Digital Lock R2

■ H X W X D = Height X Width X Depth

LFC 31 Series (31" width)	LFC 2-31	LFC 3-31	LFC 4-31
Outside (mm)	H790 X W790 X D600	H1120 X W790X D600	H1450 X W790 X D600
Weight (kg)	157	228	285
Fire Class	60 Paper	60 Paper	60 Paper
■ Height includes Wheels of 60mm . ■ Drawer Inside : H267 x W637 x D384 mm (65 ℓ) ■ Color : Ivory (RAL9002)			
LFC 38 Series (38" width)	LFC 2-38	LFC 3-38	LFC 4-38
Outside (mm)	H790 X W985 X D600	H1120 X W985 X D600	H1450 X W985 X D600
Weight (kg)	184	258	339
Fire Class	60 Paper	60 Paper	60 Paper
■ Height includes Wheels of 60mm . ■ Drawer Inside : H267x W830x D384 mm (84 ℓ) ■ Color : Ivory (RAL9002)			
LFC 44 Series (44" width)	LFC 2-44	LFC 3-44	LFC 4-44
Outside (mm)	H790 X W1119 X D600	H1120 X W1119 X D600	H1450 X W1119 X D600
Weight (kg)	-	-	-
Fire Class	60 Paper	60 Paper	60 Paper
■ Height includes Wheels of 60mm . ■ Drawer Inside : H267 x W966 x D384 mm (99 ℓ) ■ Color : Ivory (RAL9002)			

Available Locking System

• Digital Lock



Digital Lock (R2 or R3)



Touch & Finger-print Lock

• Mechanical Lock



Plunger Lock



Key Lock



Key Lock & Changeable
Combination Lock

Hotel Safe

Hotel Safe offers both convenience and reliability to every user at hotels, resorts, offices and even at homes. Keep your zone more secure with diplomat Hotel Safe.

H25 Series



H25M



H25CS

H200 Series

*Spacious enough for storing a laptop computer up to 15.4"



H200M



H200N



H200C

H125 Series

*Spacious enough for storing a laptop computer up to 13.3"



H125C

■ H X W X D = Height X Width X Depth

	H25M	H25CS	H200N	H200M	H200C	H125C
Outside (mm)	H250 X W360 X D315	H250 X W350 X D250	H200 X W435 X D365	H200 X W435 X D365	H200 X W435 X D365	H125 X W400 X D350
Inside (mm)	H246 X W356 X D242	H246 X W346 X D194	H196 X W431 X D292	H196 X W431 X D292	H196 X W431 X D292	H75 X W397 X D347
Weight (kg)	13	10	12	12	12	11
Capacity (ℓ)	21	16	24	24	24	10

■ 2 Anchoring holes on the wall or on floor. ■ Color : Ivory (RAL9002) / Black (RAL7021)

Available Locking System



- **Digital Lock EDL88**
 - FND window
 - 4 to 16 digits User Code
 - Master Code System
 - Low Battery Indication
 - Built-in Alarm
 - Outside battery loading and change



- **Digital Lock NABI**
 - FND window
 - 6 digits User Code
 - Changeable Master Code System
 - Outside battery loading and change
 - Motorized bolt-work
 - **Override System** for Emergency (Option)
: Audit trail with print-out option for 100 past records



OAK
Override Audit Kit



- **Digital Lock EASY**
 - FND window
 - 4 to 6 digits User Code
 - Inside LED Light
 - Master Code System
 - Emergency Key
 - Low Battery Indication
 - Motorized bolt-work
 - **Override System** for Emergency (Option)
: Audit trail with print-out option for 100 past records



OAK
Override Audit Kit

- **Mechanical Lock Available** : Double-bit Key Lock, Key Lock

ROC Reinforced Office Cabinet

Reinforced Office Cabinet ROC Series are designed to store documents, binders or drawings against fire and theft in convenient and economical way.

- Built in accordance with the German Construction Standard DIN4102.
- Suitable for storage of oversized documents and binders etc.
- Provides protection against small fires and thefts



■ Double wall construction ①

-  Double wall construction insulated with fire-resistant glass fiber.

■ Adjustable Interior Fittings

- Shelf for File Hanger ②
- Pull-out Shelf ③
- Pull-out Drawer ④
- Pull-out File Hanger ⑤

■ 3 side-Active Bolts ⑥

■ Sophisticated Die-casting Handle ⑦

■ Refined Plinth and Plinth Cover ⑧

■ Paint & Rust Free

- Top quality urethane antirust primer coated. Durable acrylic urethane leather-tone finish in smart modern colors makes the surface more smooth and bright, preventing scratches and worn-out.
- 100% top quality galvanized steel plate and antirust refined durable paint keep rust free. Every safe is cleaned to remove toxic foreign matters before painting.

Available Locking System

● Digital Lock



Button Lock
(R2 or R3)

● Mechanical Lock

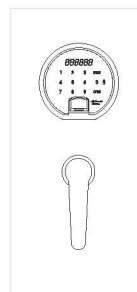

Touch Screen & Fingerprint Lock
(TFL)

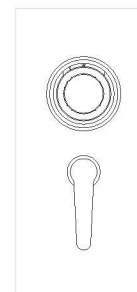

Combination Lock

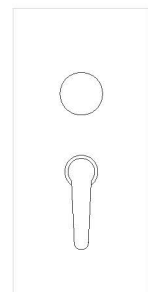

Double-bit Key Lock

ROC Reinforced Office Cabinet



ROC5201
with Key Lock

ROC5202
with Combination Lock

ROC5203
with Digital Lock R2

ROC5204
with Touch Screen & Fingerprint Lock TFL

■ H X W X D = Height X Width X Depth

	ROC5201	ROC5202	ROC5203	ROC5204
Outside (mm)	H1240 X W670 X D520	H1955 X W670 X D520	H1955 X W930 X D520	H1955 X W1200 X D520
Inside (mm)	H1045 X W560 X D400	H1760 X W560 X D400	H1760 X W820 X D400	H1760 X W1090 X D400
Weight (kg)	82	123	168	185
Capacity (ℓ)	234	394	577	767
Shelf for File Hanger	option	option	option	option
Pull-out Shelf	"	"	"	"
Pull-out Drawer	"	"	"	"
Pull-out File Hanger	"	"	"	"

■ Above weight doesn't include interior. ■ Height includes Plinth of 85mm. ■ Color : Ivory (RAL9002)

Interior

Shelf for File Hanger **Pull-out Shelf** **Pull-out Drawer** **Pull-out File Hanger**

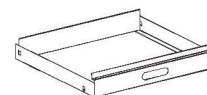
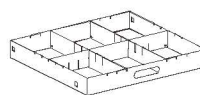
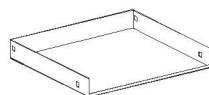

ROC 5201, ROC 5202
H25 X W550 X D367 / 1.6kg

ROC 5201, ROC 5202
H60 X W533 X D347 / 3.5kg

ROC 5201, ROC 5202
H60 X W533 X D347 / 4.5kg

ROC 5201, ROC 5202
H80 X W533 X D350 / 2kg

ROC 5203
H25 X W810 X D367 / 3kg

ROC 5203
H60 X W793 X D347 / 5kg

ROC 5203
H60 X W793 X D347 / 6kg

ROC 5203
H80 X W793 X D350 / 2.5kg

ROC5204
H25 X W1080 X D367 / 4kg

ROC5204
H60 X W1063 X D347 / 6.5kg

ROC5204
H60 X W1063 X D347 / 7.5kg

ROC5204
H80 X W1063 X D350 / 3.5kg



Security Chest & Slot Depository Safe

Compact Security Chest for easy and complete cash management versatility. Designed to secure documents and valuables at homes and for cash handling businesses, travel agents and so on.



■ H X W X D = Height X Width X Depth

	SC30 (S)	SC42 (S)	SC50 (S)	SC58 (S)
Outside (mm)	H300 X W380 X D380	H420 X W380 X D380	H500 X W380 X D380	H580 X W380 X D380
Inside (mm)	H288 X W354 X D315	H408 X W354 X D315	H488 X W354 X D315	H568 X W354 X D315
Weight (kg)	45	55	63	71
Capacity (ℓ)	32	44	54	61
Shelf (pc)	1	1	1	1

■ Steel Thickness : Door 12mm, Body 6mm ■ 4 Anchoring Holes on the floor ■ Color : Ivory (RAL9002) / Black (RAL7021)

Depository Safe

Depository safe designed for cash handling businesses such as 24 hour stores provides immediate deposit and storage for cash notes and coins, and offers instant protection from burglary.



■ H X W X D = Height X Width X Depth

	DS20	DS25	DS30
Outside (mm)	H514 X W356 X D356	H635 X W430 X D430	H762 X W508 X D508
Inside (mm)	H257 X W349 X D295	H378 X W409 X D370	H501 X W487 X D447
Weight (kg)	39	56	85
Capacity (ℓ)	27	57	109
Shelf (pc)	-	1	1

■ Steel Thickness : Door 9.0mm, Body 3.2mm ■ 4 Anchoring Holes on the floor ■ Color : Ivory (RAL9002) / Black (RAL7021)

Key Cabinet

Designed for easy handling keys in offices or stores.



KC64

KC100

KC200

■ H X W X D = Height X Width X Depth

	KC64	KC100	KC200
Outside (mm)	H364 X W344 X D135	H555 X W430 X D179	H555 X W430 X D179
Inside (mm)	H360 X W340 X D59	H378 X W409 X D370	H762 X W508 X D508
Weight (kg)	12	23	26
Capacity (ℓ)	64 keys	100 keys	200 keys

■ 6(KC64) or 9(KC100, KC200) Anchoring Holes on the Back

■ Color : Ivory (RAL9002) / Black (RAL7021)

Cash Box

It is used for keeping coins, small notes and documents temporarily during the working hours in the offices and stores. Even at home Diplomat Cash Box will give you more convenience and satisfaction.



CD320

CB302

CB305

CB330

■ H X W X D = Height X Width X Depth

	CB320	CB302	CB305	CB330
Outside (mm)	H130 X W320 X D240	H155 X W365 X D250	H150 X W330 X D390	H160 X W330 X D410
Weight (kg)	3.2	3.8	5.0	4.9
Packing	8 pcs/box	6 pcs/box	4 pcs/box	4 pcs/box

FDB, Fire Deposit Box

FDB Series are composed of Fire Resistant Safe and Safety Deposit Boxes. Applicable fields : Bank, Hotel, Golf Club, Sports Club, Resort Center, etc

P Certified by SP 60 Paper
Certificate No. 164903, 164906



Dual Locks System



FDB200



FDB300

■ H X W X D = Height X Width X Depth

	FDB200	FDB300
Outside (mm)	H1690 X W775 X D730	H1745 X W1126 X D730
Inside (mm)	H1450 X W595 X D520	H1505 X W946 X D520
Weight (kg)	609	888
Fire Class	120 Paper	120 Paper

■ Height includes Wheels of 60mm . ■ Color : Ivory (RAL9002)

Available Locking System

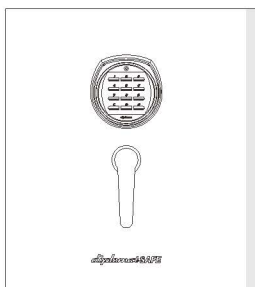

Digital Lock R2 or R3

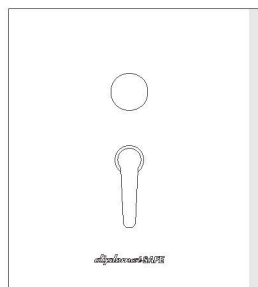

Double-bit Keylock





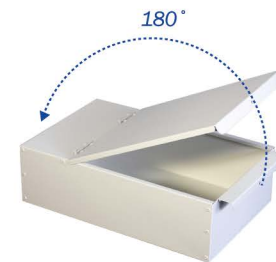

Bond Box Supporter





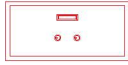

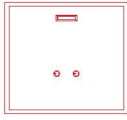
Bond Box

■ Dimension of Box

Type	A	B	C	D	E	F
						
Door (mm)	H117 x W127.5	H158 x W127.5	H93 x W266	H117 x W266	H158 x W266	H240 x W266
Bond Box (mm)	H74 x W104	H114 x W104	H40 x W242	H74 x W242	H114 x W242	H190 x W242

■ FDB200 (Box Assembly)

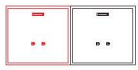

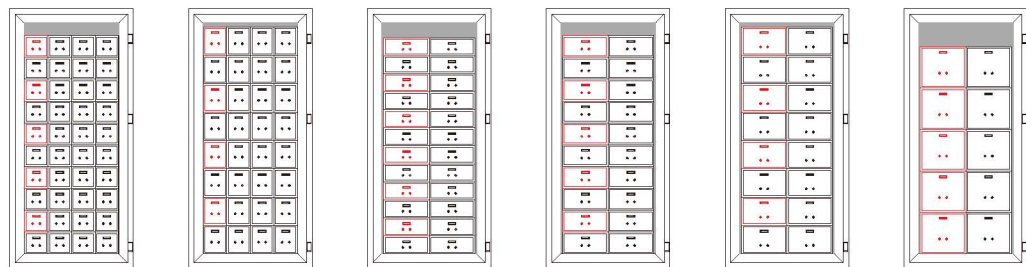



Type	A8	B8	C4	D4	E4	F2
						
Nrs of Box	8	8	4	4	4	2
Dimension (mm)	H254.5 x W563	H336.3 x W563	H205.4 x W563	H254.5 x W563	H336.3 x W563	H254.5 x W563
Wt (kg)	44	50.5	31.5	35	40	27



Nrs of Box	40	32	24	20	16	10
------------	----	----	----	----	----	----

• Dimension : Depth 500mm • Virtual combination

■ FDB300 (Box Assembly)

Type	A12	B12	C9	D6	E6	F3
						
Nrs of Box	12	12	9	6	6	3
Dimension (mm)	H254.5 x W840	H336.3 x W840	H303.6 x W840	H254.5 x W840	H336.3 x W840	H254.5 x W840
Wt (kg)	65.5	74.5	68	51.5	59	40

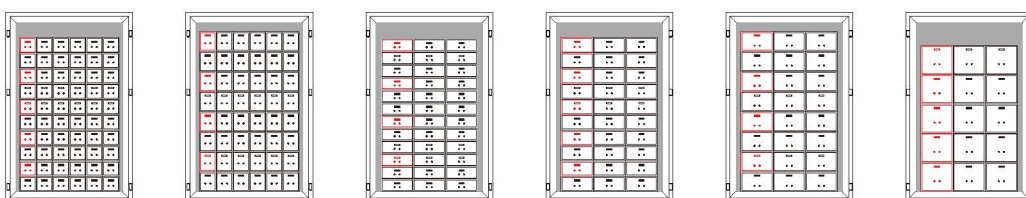

Nrs of Box	60	48	36	30	24	15
------------	----	----	----	----	----	----

• Dimension : Depth 500mm • Virtual combination

DB, Deposit Box

DB Series has upward door opening system and the door automatically opens when unlocked. Much more improved than conventional DBs in convenience and security.



- **Automatic door opening system** gives more convenience. When a customer unlocks the door, it opens upward and the bond boxes automatically slide out.
- **Durable security** Compared with one lock system, DB's two locks system provides durable security. With steel reinforcement in front, each box is more resistant against drilling outside.
- **Space save and easy installment** Compact deposit boxes save space in installment. Upward opening door requires less space in the right side.

Type	A24	B18	C15	D12	E9	F6
Nrs of Box	24	18	15	12	9	6
Dimension (mm)	H500 x W840	H500 x W840	H500 x W840	H500 x W840	H500 x W840	H500 x W840
Wt(kg)	125.5	110	110	98.5	86.5	74.5

• Dimension : Depth 500mm

Example	I	II	III	IV	V	VI
C15	1	-	-	-	-	-
D12	1	4	-	1	-	-
E9	1	-	4	1	2	-
F6	1	-	-	2	2	4
Nrs of Box	42	48	36	33	30	24

Digital Locks

EDL88, R3 (Button Digital Lock)



- FND window
- User Code : 4 to 16 digits
- Master Code System
- Code Hide System
- Scramble Numbers
- Dual Locking with two codes
- Paralysis Function
- Low Battery Indication
- Built-in Alarm
- Reset Function

EDL77, R2 (Button Digital Lock)



- User Code : 4 to 16 digits
- Master Code System
- Paralysis Function
- Reset Function

TFL (Touch Screen & Fingerprint Lock)



- FND window
- Operated with user code or finger print
- User Code : 4 to 16 digits
- 128 finger prints are acceptable
- Master Code System
- Code and Sound Hide System
- Scramble Numbers
- Dual Locking with two codes
- Paralysis Function
- Low Battery Indication
- Built-in Alarm
- Reset Function

TSL (Touch Screen Lock)



- User Code : 4 to 16 digits
- 5 different user's code available
- Master Code System
- Scramble Numbers
- Sound Hide System
- Paralysis Function
- Low Battery Indication
- Built-in Alarm
- Reset Function

NABI (Button Digital Lock)



OAK

- FND window
- User Code : 6 digits
- Changeable Master Code System
- Outside battery loading and change
- **Override System for Emergency (Option)**
: Audit trail with print-out option for 100 past records

EASY (Button Digital Lock)



OAK

- FND window
- User Code : 6 digits
- Inside LED Light
- Master Code System
- Emergency Key
- Low Battery Indication
- **Override System for Emergency (Option)**
: Audit trail with print-out option for 100 past records

Main PCB

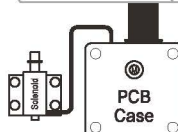
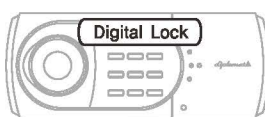

Solenoid type
Applicable
Model 119 ~ 530

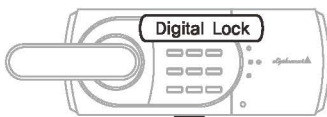

Swing-bolt type
Applicable
Above model 060

Certificate Labels

CE Electromagnetic safety test CE certification

RoHS 6 hazardous substances compliance with use restrictions in EU



Diplomat Safe tries to make the world safe and sound.

diplomat[®] **SAFE** 

19 NoksanSandan 261Ro 60Gil Gangseo-gu Busan, Korea TEL (82 51)831-4400 FAX (82 51)831-4409
Email : info@dsafe.co.kr www.dsafe.kr

